

cheap ficha técnica datasheet

ref. 5551861

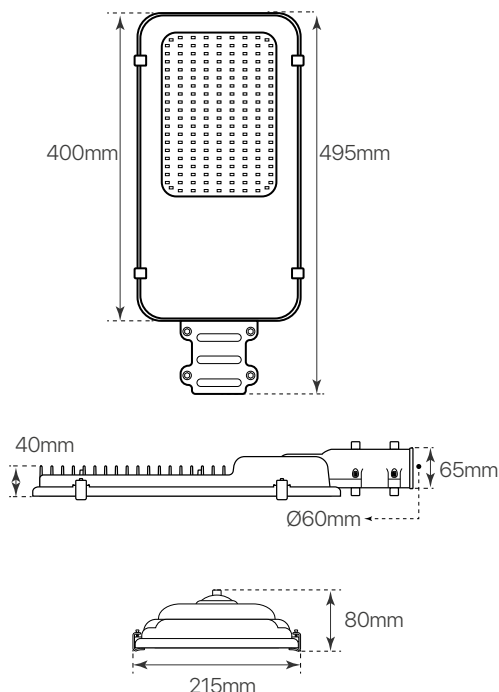

The average Illuminance Effective Figure

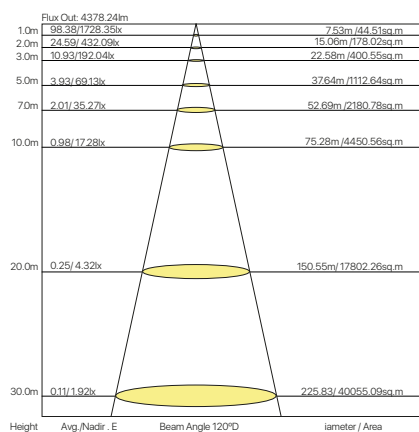

Nombre / Name	Cheap • vial led
Referencia / Reference	5551861
Materiales / Materials	Aluminio + Cristal / Aluminum + Glass
Difusor / Diffuser	-
Potencia / Power	50W
Temperatura de color / Color temperature	3000K
Flujo luminoso / Luminous flux	5200lm
Dimable / Dimmable	-
Ángulo de apertura / Beam angle	120°
Ángulo de inclinación / Inclination angle	-
IP	65
IK	08
F.P	>0,9
UGR	<19
IRC	>70
Chip	PHILIPS SMD 3030
Driver	i-TEC series
Vida media (duración) / Average life	± 30,000 h
Clase energética / Energy class	A++
Aislamiento eléctrico / Electrical isolation	Clase I / Class I
Colores / Colors	Gris plata / Grey silver
Medida exterior / Product size	495mm x 215mm x 80mm
Protección contra Sobretensiones / surge protections	5kV
Tª (ambiente/trabajo) / Tª (enviroment/work)	-25°C ~60°C
Input	AC 85 ~ 265V
Output	DC 32V
Frecuencia / Frequency	50/60Hz
Peso / Weight	2,5kg
Certificados / Certificates	CE&RoHS
Garantia / Warranty	2 años